

# National Detroit, Inc.

P.O. Box 2285 ■ Rockford, IL 61131  
 (815) 877-4041 ■ Fax (815) 877-4050  
 email: NationalDetroit@compuserve.com  
 website: http://www.NationalDetroit.com

Shipping Address:  
 1590 Northrock Court  
 Rockford, IL 61103

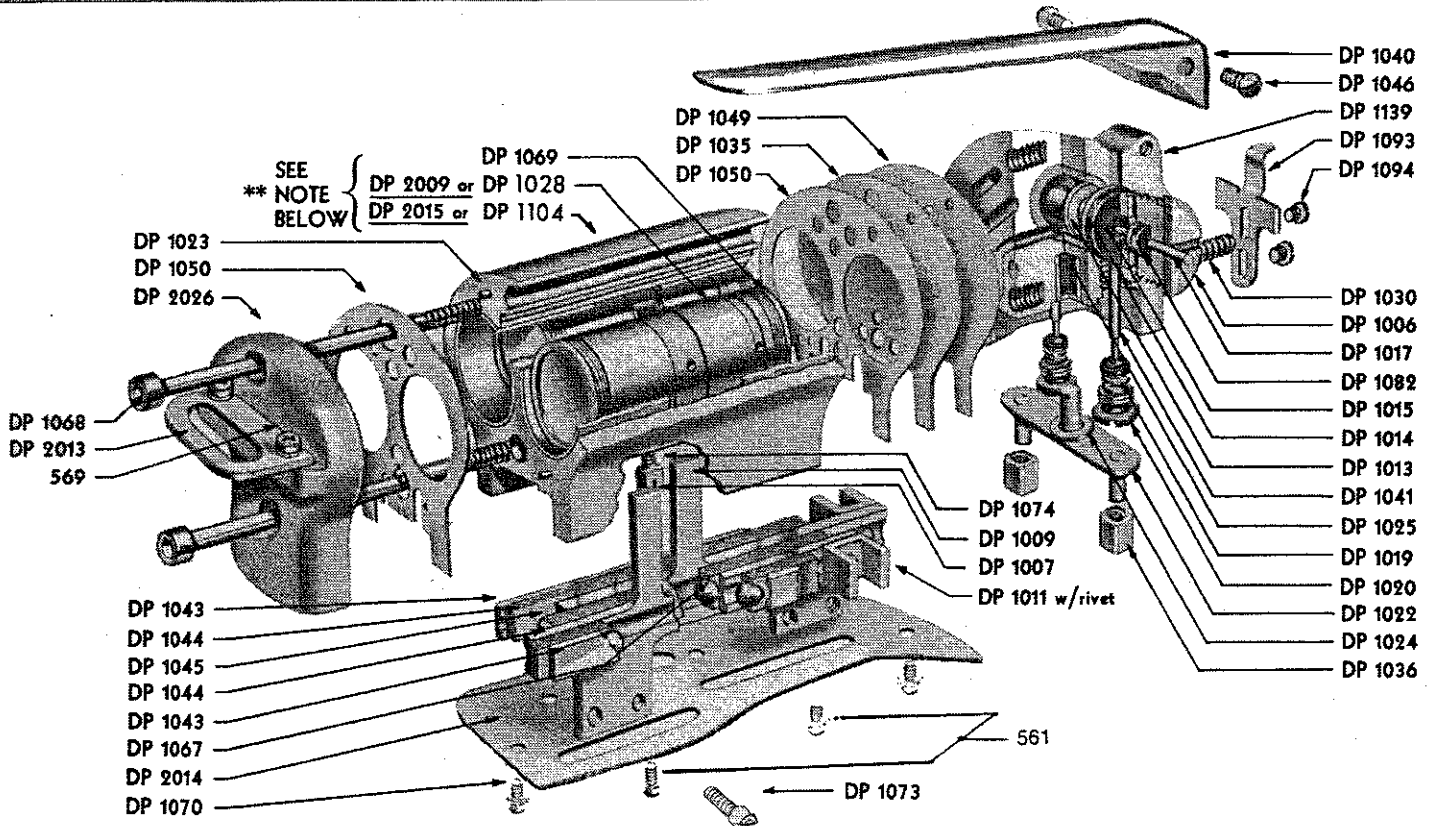

Part No.	Description
561	Bottom Cover Plate Side Screw-4
569	Hanger Hook Screw w/washer-2
DP 1006	Shuttle Valve Plug-2
DP 1007	L. H. Slide Sub Assembly
DP 1009	R. H. Slide Sub Assembly
DP 1011	Equalizer Fork w/rivets-2
DP 1013	Shuttle Valve
DP 1014	Shuttle Valve Washer-2
DP 1015	Shuttle Valve Rubber Washer-2
DP 1017	Valve Push Pin-2
DP 1019	Valve Spring-2
DP 1020	Valve Spring Plug-2
DP 1022	Equalizer Sub Assembly
DP 1024	Equalizer Bearing Spacer
DP 1025	Equalizer Bearing
** DP 1028	Piston-2
DP 1030	Trigger Latch Spring
DP 1035	Spacer Plate
DP 1036	Equalizer Block-2
DP 1040	Trigger
DP 1041	Valve Stem-2
DP 1043	Outer Ball Bearing Race-2
DP 1044	Side Bearing Retainer-2
DP 1045	Center Bearing Retainer
DP 1046	Trigger Screw-2
DP 1049	Spacer Plate Gasket

Part No.	Description
DP 1050	End Cap Gasket-2
DP 1067	Bearing Ball-16
DP 1068	Assembly Bolt-2
DP 1069	Piston Ring-4
DP 1070	Bottom Cover Plate Screw-2
DP 1073	Pad Shoe Bolt-4
DP 1074	Water Fitting
DP 1082	Leather Washer-2
DP 1093	Trigger Latch
DP 1094	Trigger Latch Screw-2
** DP 1104	Cylinder Housing Sub Assembly
DP 1139	Valve Head Sub Assembly
DP 2013	Hanger w/screws and washers
DP 2014	Bottom Cover Plate
DP 2026	End Cap
* DP 2027	.005" Shuttle Valve Spacer
* DP 2028	.015" Shuttle Valve Spacer
** <u>DP 2009</u>	Piston-2
** <u>DP 2015</u>	Cylinder Housing Sub Assembly

\*\* Note:-Underscored parts DP 2009 and DP 2015 are used on the Model 300A. All other parts are interchangeable on Model 300 or 300A.

\* Not Shown

**SEE OTHER SIDE FOR PADS AND ACCESSORIES**

All machines are serially numbered. The Model 300 serial number is prefixed by 3- and the Model 300A serial number is prefixed by 3A-. When ordering parts please include serial number of machine for which parts are intended.

# NATIONAL DETROIT MODEL 300 AND 300A

**CAUTION: READ AND OBSERVE THE ENCLOSED WARNINGS  
AND SAFETY RULES FOR SAFE OPERATION.**

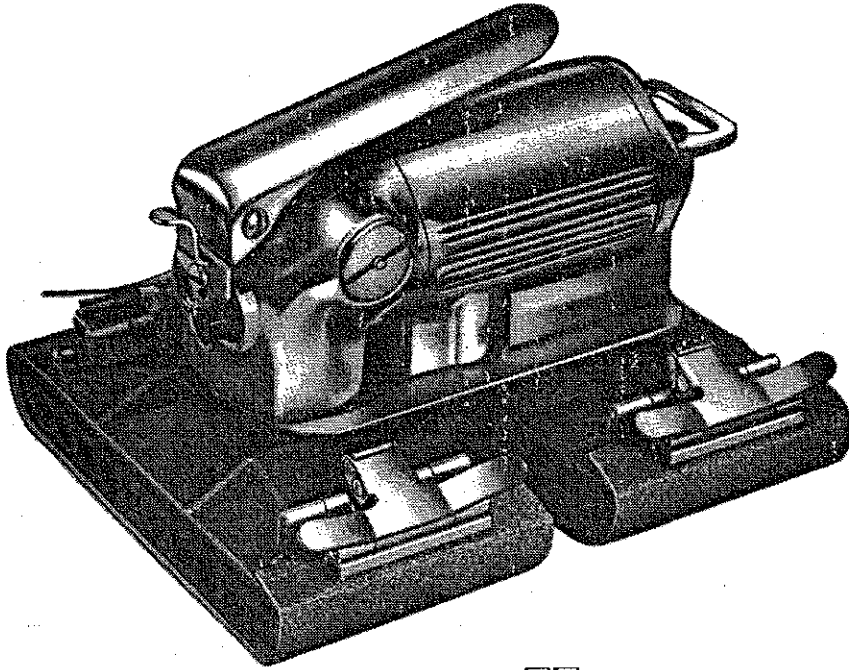

National Detroit Models 300 and 300A are straight-line action two-pad air sanders with built-in water spray for wet sanding. Six different pads and two sizes of pad shoes are available for these sanders, each of which is designed for a specific finishing operation. Pads, shoes, and accessories are at the bottom of this page. Pads and shoes are easily and quickly interchanged.

### SPECIFICATIONS

	MODEL 300	MODEL 300A
Weight	6 lbs. body only	6 lbs. body only
Pad Stroke	3/4" each pad	1/2" each pad
Air Pressure Required	60 to 100 PSI	60 to 100 PSI
Abrasive Area	Up to 50 Sq. In.	Up to 50 Sq. In.
Speed	2250 3/4" strokes per min. per pad	2500 1/2" strokes per min. per pad
Air Consumption	7 CFM	7 CFM
Paper Size	See Below	See Below
Backing Pad	See Below	See Below

No extra charge for wet sanding attachment.  
Ball Bearing Construction.

3-2645-2 Lubro-Control Unit  
3-0-552 Filter  
3-20-40-2 Lubricator  
3-2A (505) Regulator W/gauge

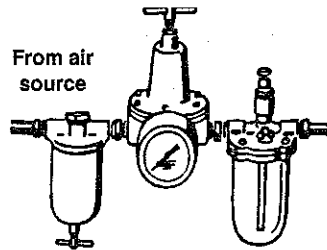

## SANDING PADS AND ACCESSORIES FOR MODEL 300 AND 300A SANDERS

All machines are serially numbered. The Model 300 serial number is prefixed by 3- and the Model 300A serial number is prefixed by 3A-. When ordering parts please include serial number of machine for which parts are intended.

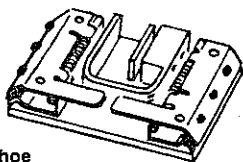

DP 2018 Sanding Shoe  
2-7/8" x 4-3/4"

Paper Holder DP 2010-R  
DP 2012-L

Rubber Bumper DP 2023  
Paper holders not included with shoe.

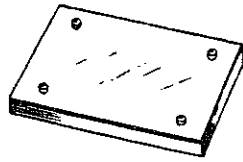

DP 1087-1 1/2" Neoprene Sponge  
Paper Size 3" x 8"

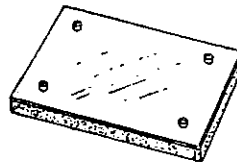

DP 1088 1/2" Felt  
Paper Size 3" x 8"

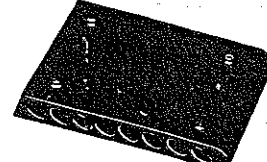

DP 2017 Molded Neoprene  
Paper Size 2-3/4" x 9"

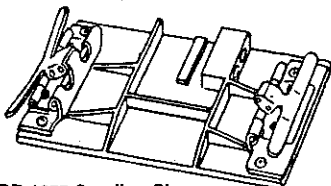

DP 1055 Sanding Shoe  
3-1/2" x 6-1/2"

Paper Holder DP 2038  
Rubber Bumper 6210

Paper holders not included with shoe.

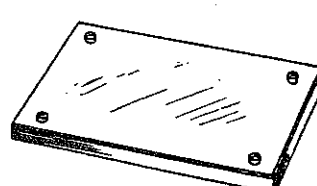

DP 1084 1/2" Neoprene Sponge  
Paper Size 3-2/3" x 9"

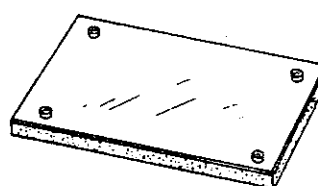

DP 1085 Felt  
Paper Size 3-2/3" x 9"

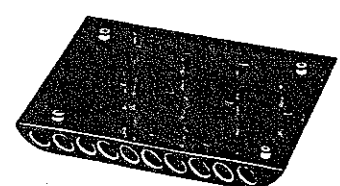

DP 1086 Molded Neoprene  
Paper Size 3-2/3" x 9"